



*Accuracy is our mantra*

# R. R. ENGINEERING WORKS

HOUSE OF BLOW MOULDING MACHINE'S SOLUTIONS

Gala No. 3, Tirupati Industrial Estate, Survey No. 113/2/1, Amla, Silvassa - 396 230. (D&NH)

Mob.: 09662011953, 07359404201 | E-mail : rnetke@yahoo.com, salesrreng@gmail.com, rrengineeringsilvassa@gmail.com

Website : [www.rrengineering.in](http://www.rrengineering.in)

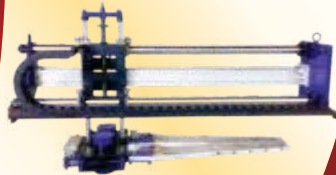

## POST COOLER

(for 5 Ltr. to 100 Ltr. Barrels)



### Model : PC - L - S - 1

- PC - Post Cooler
- L - 5 Ltr. to 100 Ltr.
- S - Cylinder Stroke
- 1/2/3 - Single / Two / Three Station

## LEAK TEST UNIT COMBINATION WITH DRILLING STATION

(for 210 Ltr. to 250 Ltr.)



### Model : LT - D - L

- LT - Leak Test Unit
- D - Drilling Station
- L - Barrel Capacity in Ltr.

### Technical Specification

1. Size - W1000 x L1000 x H1300mm Hight.
2. Pneumatic Cylinder - 150mm Bore x 300mm Stroke Double Ended.
3. Press. Transducer - 0 to 200 Mbar.

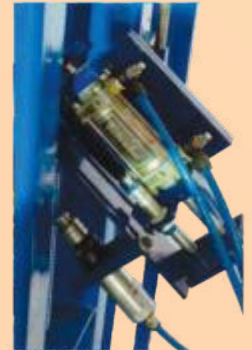

## DRILLING STATION

(for 210 Ltr. to 250 Ltr.)

### SINGLE STATION

(for 210 Ltr. to 250 Ltr.)



### 2 STATION

(for 210 Ltr. to 250 Ltr.)



## 3 STATION POST COOLER



### Technical Specification of Single Station

1. Size : W1200 x L2500 x H1430 mm hight.
2. Pneumatic cylinder : 150 mm bore x 300 mm stroke.
3. Blowers : Vacuum and Compressor type / Rotor Type Centrifugal Blower.
4. Can be use compressed air or Blower Air for Cooling the Barrels.
5. Top and Bottom Plates : Water Cooled.
6. Barrel Top and Bottom ring Cooling by Blower Air.
7. Timer for Cooling Time and Auto Cut - Off.



**Note : Due to constant process of design improvement, dimensions and specification may change without prior notice.**

# VERTICAL MIXER (Available with M.S. and S.S. Material)

## MODEL :

VM	M.S. / S.S.	100/250/500/1000/2000	2 / 3 / 5
A	B	C	D

A - Vertical Mixer  
 B - Type of Vessel Material  
 C - Mixing Capacity in kg.  
 D - Motor Power Consumption 2 HP / 3 HP / 5 HP

## BOTTOM SIDE CLEANING WINDOW



## VERTICAL MIXER 500 KG. CAPACITY

Model : VM-M.S.-500-3-SB  
 Main Motor - 3 HP  
 Batch Capacity - 500kg.  
 Vessel Capacity - 550kg.  
 Batch Time - 20 min. to 25 min.



## VERTICAL MIXER 250 KG. CAPACITY

Model : VM-M.S.-250-2  
 Main Motor - 2 HP  
 Batch Capacity - 250kg.  
 Vessel Capacity - 260kg.  
 Batch Time - 10 min. to 15 min.



## VERTICAL MIXER 100 KG. CAPACITY

Model : VM-M.S.-100-2  
 Main Motor - 2 HP  
 Batch Capacity - 100kg.  
 Vessel Capacity - 110kg.  
 Batch Time - 10 min. to 15 min.

## MULTI FEEDING HOPPERS



## Features :

- The spiral type material mixer is suitable for mixing and color mixture of various kinds of plastic raw materials with granular solid state and the color master batch, and this machine is large-scale equipment for mixing 5 plastics. It has overcome various kinds of mixing defects and drawbacks of traditional material mixers, so it is the ideal auxiliary equipment in the process and production of extrusion and injection of plastics.
- The standing operation results in little land occupation.
- Mixing with a sealed type, with even material mixing and no leak age of materials definitely.
- Small horsepower, great mixing amount, so fast that can get event mixing in 10-15 minutes.
- Working principle is adopted to VM Series of Large-capacity Vertical Mixer. Firstly feed the product into the Hopper, then the mixer conveys the product to the top of the barrel, then the product drops as scattering about, simultaneously keep mixing, therefore to have the product mixed well.
- Specifications of VM Series of Vertical Mixer : Automatic Working Timing, Overloading Protecting, Space-saving, Large products, flakes of Plastic, Mixture of Plastic Products, Master Batch adding and Mixing.

**Note : Due to constant process of design improvement, dimensions and specification may change without prior notice.**

# HOPPER LOADER (for 20 Ltr. to 1000 Ltr.)



## Model : HL - S/V - SL - M - H - L - SB

- HL - Hopper Loader
- S/V - Spiral Flow / Vaccum Type
- SL - Spring Length • M - Electric Motor H.P.
- H - High Level Sensor • L - Low Level Sensor
- SB - Storage Bin Capacity in kg.

## SPIRAL FLOW HOPPER LOADER

Reliable method of materials transfer. Widely used to handle all kinds of powder, granules, pellets and flake materials.

### NO. DESCRIPTION

- | NO. | DESCRIPTION            |
|-----|------------------------|
| 1.  | Storage Bin            |
| 2.  | Horizontal Inlet       |
| 3.  | HDPE Outer Tube        |
| 4.  | Flexible Spiral Spring |
| 5.  | High Level Control     |
| 6.  | Low Level Control      |
| 7.  | Feeding Hopper         |
| 8.  | Electric Motor         |

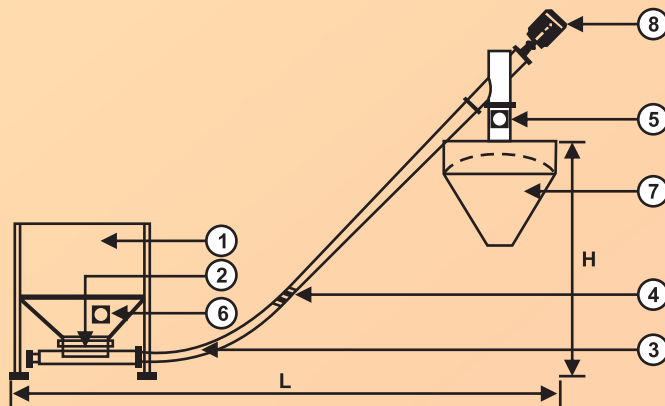

# SCREW FEEDER



Note : Due to constant process of design improvement, dimensions and specification may change without prior notice.

## VERTICAL MIXTURE WITH DRYER (Available with M.S. and S.S. Material)

### MODEL :

VM	M.S. / S.S.	100/250/500/1000/2000	2/3/5	D
A	B	C	D	E

A - Vertical Mixture  
 B - Type of Vessel Material  
 C - Mixing Capacity in kg.  
 D - Motor Power Consumption 2 HP / 3 HP / 5 HP  
 E - With Dryer

◆ While sending your enquiry for quotation pl. mention the dimensions (L) and (H) in meters.



### Features :

- Synchronization of mixing and drying : as a result of the non-stop flow of the products during its drying, the heat acts equably on the products, just a short drying time is needed and not easy to agglomerate.

## HIGH SPEED MIXER

### MODEL :

HSM	M.S. / S.S.	25/50/100	12.5/20/40
A	B	C	D

A - High Speed Mixer  
 B - Type of Vessel Material  
 C - Batch Capacity in Kg.  
 D - Power Consumption in HP



## UNLOADER GRIPPER (for 20 Ltr. to 2000 Ltr. Machine)

## OVEN FOR PLASTIC LUGS

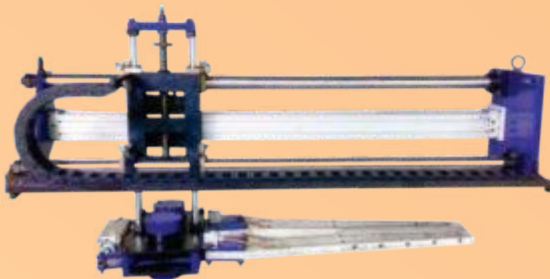

### Model : UN - S - B - L

- UN - Unloader Gripper
- S - Cylinder Stroke
- B - Cylinder Bore
- L - Machine Capacity in Ltr.



**Note : Due to constant process of design improvement, dimensions and specification may change without prior notice.**

## PRINTING MACHINE FOR BARRELS



**PRINTING MACHINE  
MANUALLY 210 ltr. to 250 ltr.**

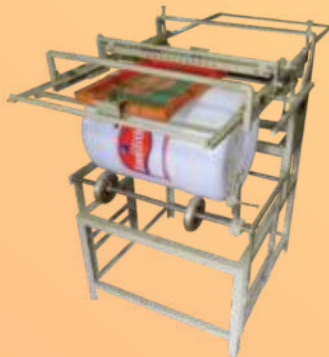

**PRINTING MACHINE  
60 ltr.**

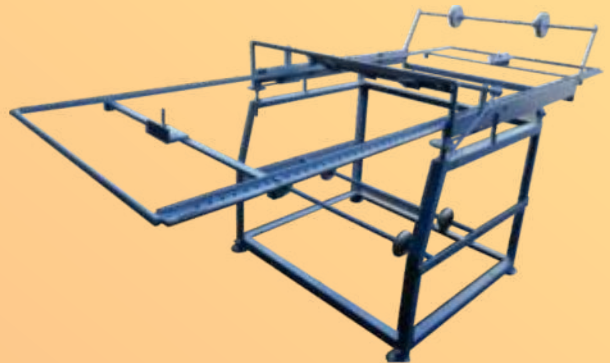

**PRINTING MACHINE  
SEMI AUTO 210 ltr. to 250 ltr.**

### SILO FOR GRINDER



### CIRCULAR SAW (DRUM CUTTER) WITH DUST COLLECTOR



**Technical Specification**

1. Size - W800 x L1200
2. 3HP motor
3. Cutting Dust Collecting Arrangement

### OPEN TOP CLAMP FITTING MACHINE

For 30 Ltr. to 250 Ltr. Barrels



### BLOW PIN TABLE (For 210 ltr. Machine)



**Jagmohan Machine**

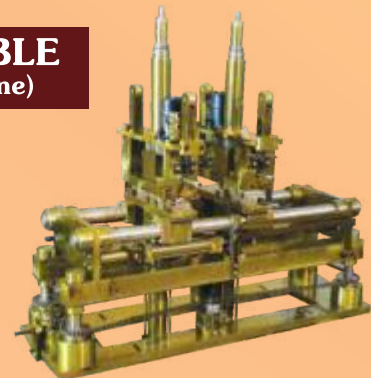

**Vinitha Machine**

## OUR VALUED CUSTOMERS

TIME TECHNOPLAST LTD	DAMAN	M.KAK INDUSTRIES	HUBLI
BSA POLYCONTAINER	SILVASSA	REDICAL PLASTPACK PVT. LTD.	UTTRAKHAND
VICKRAM PLASTICIZER	SILVASSA	VECTUS INDUSTRIES LTD.	TUMKUR
TPL PLASTECH LTD.	SILVASSA	MITSU CHEM PVT. LTD.	TARAPUR
HARLEM POLYCONTAINER PVT LTD.	SILVASSA	JARAIKELA LUMBARMAN (I) LTD.	KOLKATA
ABHISHRI POLYCONTAINER	SILVASSA	BLOW PACKING (INDIA) PVT. LTD.	CHENNAI
JAGMOHAN PLA-MACH PVT. LTD.	MUMBAI	H. S. CONTAINERS PVT. LTD.	HYDERABAD
ARYAN INDUSTRIES LTD.	MUMBAI	SAIKALA POLYMERS	HYDERABAD
PRUTHVIRAJ PLASTICS PVT. LTD.	PUNE	C.K.FABRICS PVT. LTD.	HYDERABAD
G.S.PLASTIC INDUSTRIES	DEHLI	SAI SULPHONATES PVT. LTD.	KOLKATA
N. B. COMMERCIAL ENTERPRISES PVT. LTD.	AHMEDABAD	TANVI SPRINKLERS	KARNATAKA
JAGLAXMI PLASTPACK PVT. LTD	M.P.	EMINET POLYFILMS	VISAKHAPATNAM
PROGEOCHEM INDUSTRIES PVT. LTD.	NEPAL	<b>AND MANY MORE VALUED CUSTOMERS....</b>	